

# Air-Conditioners

## SEZ-KA35, KA50, KA60VA

### OPERATION MANUAL

**FOR USER**

For safe and correct use, please read this operation manual thoroughly before operating the air-conditioner unit.

### BEDIENUNGSHANDBUCH

**FÜR BENUTZER**

Zum sicheren und einwandfreien Gebrauch der Klimaanlage dieses Bedienungshandbuch vor Inbetriebnahme gründlich durchlesen.

### MANUEL D'UTILISATION

**POUR L'UTILISATEUR**

Pour une utilisation correcte sans risques, veuillez lire le manuel d'utilisation en entier avant de vous servir du climatiseur.

### BEDIENINGSHANDLEIDING

**VOOR DE GEBRUIKER**

Voor een veilig en juist gebruik moet u deze bedieningshandleiding grondig doorlezen voordat u de airconditioner gebruikt.

### MANUAL DE INSTRUCCIONES

**PARA EL USUARIO**

Lea este manual de instrucciones hasta el final antes de poner en marcha la unidad de aire acondicionado para garantizar un uso seguro y correcto.

### ISTRUZIONI DI FUNZIONAMENTO

**PER L'UTENTE**

Leggere attentamente questi istruzioni di funzionamento prima di avviare l'unità, per un uso corretto e sicuro della stessa.

### ΕΓΧΕΙΡΙΔΙΟ ΟΔΗΓΙΩΝ ΧΡΗΣΕΩΣ

**ΓΙΑ ΤΟΝ ΧΡΗΣΤΗ**

Για ασφάλεια και σωστή χρήση, παρακαλείστε διαβάσετε προσεχτικά αυτό το εγχειρίδιο χρήσεως πριν θέσετε σε λειτουργία τη μονάδα κλιματισμού.

### MANUAL DE OPERAÇÃO

**PARA O UTILIZADOR**

Para segurança e utilização correctas, leia atentamente o manual de operação antes de pôr a funcionar a unidade de ar condicionado.

### DRIFTSMANUAL

**FÖR ANVÄNDAREN**

Läs denna driftsmanual noga för säkert och korrekt bruk innan luftkonditioneringen används.

**English****Deutsch****Français****Nederlands****Español****Italiano****Ελληνικά****Português****Svenska**

# Contents

1. Safety Precautions .....	2
2. Operation .....	3
3. Care and cleaning .....	13
4. Troubleshooting .....	13
5. Installation, relocation and inspection .....	14
6. Specifications .....	15

## 1. Safety Precautions

- ▶ Before installing the unit, make sure you read all the “Safety precautions”.
- ▶ The “Safety precautions” provide very important points regarding safety. Make sure you follow them.
- ▶ Please report to or take consent by the supply authority before connection to the system.

### Symbols used in the text

#### ⚠ Warning:

Describes precautions that should be observed to prevent danger of injury or death to the user.

#### ⚠ Caution:

Describes precautions that should be observed to prevent damage to the unit.

### Symbols used in the illustrations

- ⊘ : Indicates an action that must be avoided.
- ❗ : Indicates that important instructions must be followed.
- ⚡ : Indicates a part which must be grounded.
- ⚠ : Indicates that caution should be taken with rotating parts.
- ⚡ : Indicates that the main switch must be turned off before servicing.
- ⚠ : Beware of electric shock.
- ⚠ : Beware of hot surface.

#### ⚠ Warning:

Carefully read the labels affixed to the main unit.

#### ⚠ Warning:

- The unit should not be installed by the user. Ask the dealer or an authorized company to install the unit. If the unit is installed improperly, water leakage, electric shock or fire may result.
- Do not stand on, or place any items on the unit.
- Do not splash water over the unit and do not touch the unit with wet hands. An electric shock may result.
- Do not spray combustible gas close to the unit. Fire may result.
- Do not place a gas heater or any other open-flame appliance where it will be exposed to the air discharged from the unit. Incomplete combustion may result.
- Ventilate the room if refrigerant leaks during operation.  
If the refrigerant comes in contact with a flame, poisonous gases will be released.
- Do not remove the front panel or the fan guard from the outdoor unit when it is running. You could be injured if you touch rotating, hot or high-voltage parts.
- Never insert fingers, sticks etc. into the intakes or outlets, otherwise injury may result, since the fan inside the unit rotates at high speed.
- If you detect odd smells, stop using the unit, turn off the power switch and consult your dealer.
- This air conditioner is NOT intended for use by children or infirm persons without supervision.
- Young children should be supervised to ensure that they do not play with the air conditioner.

#### ⚠ Caution:

- Do not use any sharp object to push the buttons, as this may damage the remote controller.
- Never block or cover the indoor or outdoor unit's intakes or outlets.

### Disposing of the unit

When you need to dispose of the unit, consult your dealer. If pipes are removed incorrectly, refrigerant (fluorocarbon gas) may blow out and come into contact with your skin, causing injury. Releasing refrigerant into the atmosphere also damages the environment.

## 2. Operation

### 2.1. Description of "AUTO RESTART FUNCTION"

- This unit is equipped with the auto restart function. When the main power is turned on, the air conditioner will start operation automatically in the same mode as set with the remote controller before the shutoff of main power.
- If the unit was set to off with the remote controller before the shutoff of main power, it will remain stopped even after the main power is turned on.
- If the unit was in the TEST RUN before the shutoff of main power, it will start operation, at main power on, in the same mode as set with the remote controller before the TEST RUN.

### 2.2. Setting the day of the week and time

- Use this screen to change the current day of the week and time setting.

#### Note:

The day and time will not appear if clock use has been disabled at Function Selection of remote controller.

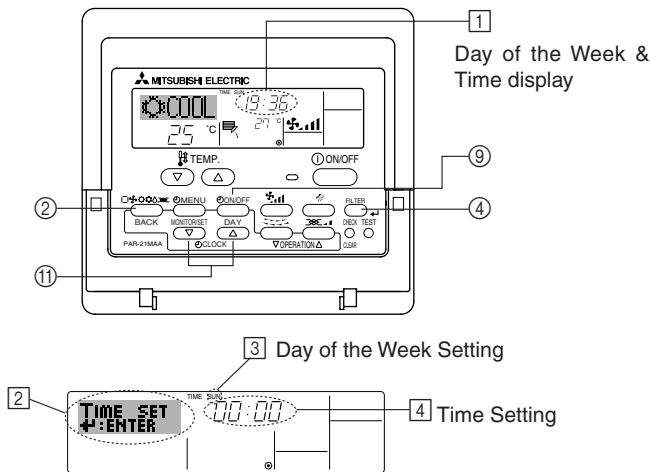

#### ► How to Set the Day of the Week and Time...

1. Press the  $\nabla$  or  $\Delta$  Set Time button (11) to show display (2).
2. Press the Timer On/Off (Set Day) button (9) to set the day.
  - \* Each press advances the day shown at (3): Sun → Mon → ... → Fri → Sat.
3. Press the appropriate Set Time button (11) as necessary to set the time.
  - \* As you hold the button down, the time (at (4)) will increment first in minute intervals, then in ten-minute intervals, and then in one-hour intervals.
4. After making the appropriate settings at Steps 2 and 3, press the Filter  $\leftarrow$  button (4) to lock in the values.

#### Note:

Your new entries at Steps 2 and 3 will be cancelled if you press the Mode (Return) button (2) before pressing the Filter  $\leftarrow$  button (4).

5. Press the Mode (Return) button (2) to complete the setting procedure. This will return the display to the standard control screen, where (1) will now show the newly set day and time.

### 2.3. Switching the unit on/off

- The power supply should not be turned off while the air conditioner is in use. This can cause the unit to break down.

- (1) Press the ON/OFF button.

(A) The ON indicator should light up.

- Even if you press the ON/OFF button immediately after shutting down the operation in progress, the air conditioner will not start for about three minutes. This is to prevent the internal components from being damaged.
- If the operation stops due to a power failure, the unit will not automatically restart until the power has been restored. Press the ON/OFF button to restart.

### 2.4. Mode select

- (1) If the unit is off, press the ON/OFF button to turn it on.

(A) The ON indicator should light up.

- (2) Press the operation mode ( $\square$   $\odot$   $\odot$   $\odot$ ) button and select the operation mode.

(B)

$\odot$  (COOL) Cooling mode

$\odot$  (DRY) Drying mode

$\odot$  (FAN) Fan mode

$\odot$  (HEAT) Heating mode

$\square$  (AUTO) Automatic (cooling/heating) mode

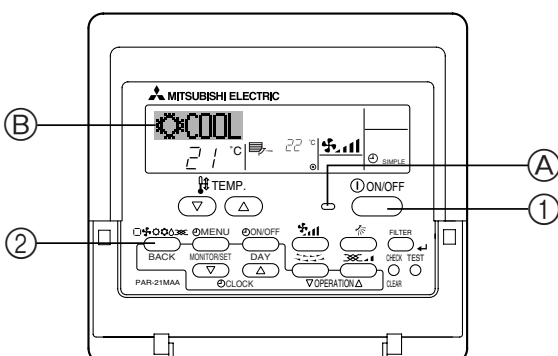
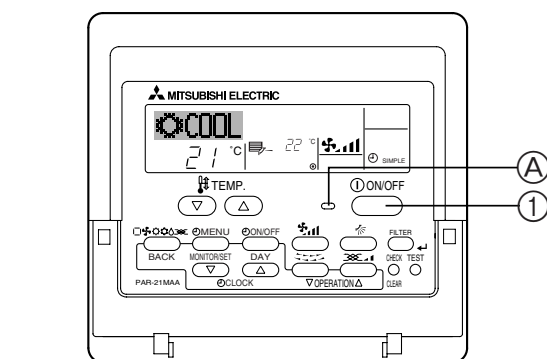

## 2. Operation

### Information for multi system air conditioner (Outdoor unit: MXZ series)

► Multi system air conditioner (Outdoor unit: MXZ series) can connect two or more indoor units with one outdoor unit. According to the capacity, two or more units can operate simultaneously.

- When you try to operate two or more indoor units with one outdoor unit simultaneously, one for the cooling and the other for heating, the operation mode of the indoor unit that operates earlier is selected. The other indoor units that will start the operation later cannot operate, indicating an operation state.

In this case, please set all the indoor units to the same operation mode.

- There might be a case that the indoor unit, which is operating in  (AUTO) mode. Cannot change over to the operating mode (COOL ↔ HEAT) and becomes a state of standby.
- When indoor unit starts the operation while the defrosting of outdoor unit is being done, it takes a few minutes (max. about 15 minutes) to blow out the warm air.
- In the heating operation, though indoor unit that does not operate may get warm or the sound of refrigerant flowing may be heard, they are not malfunction. The reason is that the refrigerant continuously flows into it.

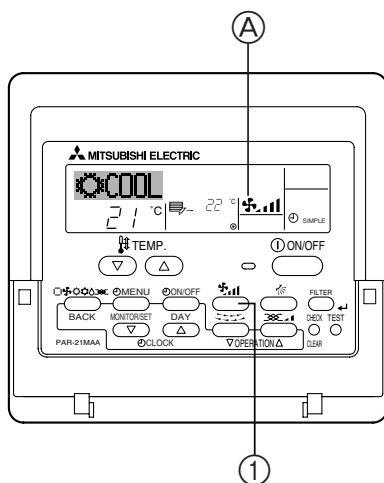
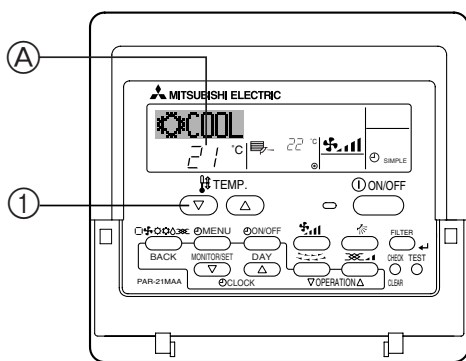

### 2.5. Selecting a temperature

► To decrease the room temperature:

- Press  button to set the desired temperature.

Ⓐ The selected temperature is displayed.

- Each time you press the button, the temperature value decreases by 1 °C.

► To increase the room temperature:

- Press  button to set the desired temperature.

Ⓐ The selected temperature is displayed.

- Each time you press the button, the temperature value increases by 1 °C.

- Available temperature ranges are as follows:



Cooling & Drying:	19 - 30 °C
Heating:	17 - 28 °C
Automatic:	19 - 28 °C

- The display flashes either 8 °C - 39 °C to inform you if the room temperature is lower or higher than the displayed temperature.

### 2.6. Selecting a fan speed

- Press  button to select a desired fan speed.

- Each time you press the button, available options change with the display Ⓐ on the remote controller, as shown below.

Fan speed	Remote controller display	
	Low	High
2-stage	↓ 	↑ 

The display and the fan speed of the unit will differ in the following situations:

- When STAND BY and DEFROST are displayed.
- Just after the heating mode (while waiting to change to another mode).
- When the temperature of the room is higher than the temperature setting of the unit operating in the heating mode.
- In the dry operation, the indoor fan automatically turns to low-speed operation. Switching of fan speed is impossible.
- When the temperature of the heat exchanger is low in the heating mode (e.g., immediately after heating operation starts).

## 2. Operation

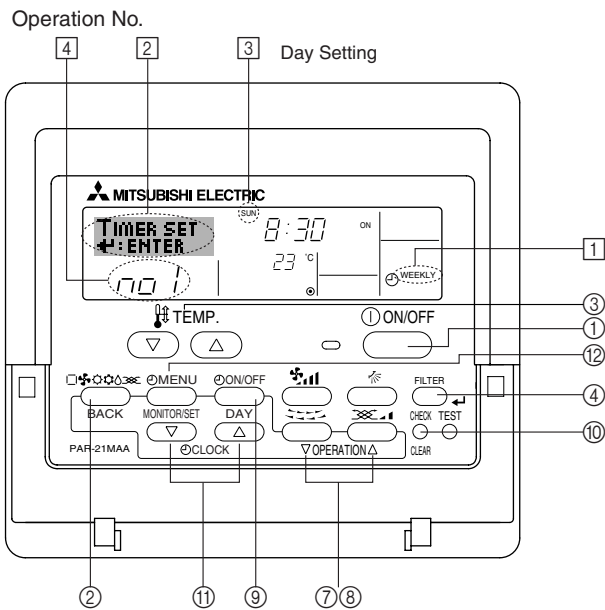

### 2.7. Using the timer

This section explains how to set and use the timer. You can use Function Selection of remote controller to select which of three types of timer to use: ① Weekly timer, ② Simple timer, or ③ Auto Off timer.

For information about how to set the Function Selection of remote controller, refer to section 2.10. [4]–3 (3).

#### 2.7.1. Using the Weekly Timer

■ The weekly timer can be used to set up to eight operations for each day of the week.

- Each operation may consist of any of the following: ON/OFF time together with a temperature setting, or ON/OFF time only, or temperature setting only.
- When the current time reaches a time set at this timer, the air conditioner carries out the action set by the timer.

■ Time setting resolution for this timer is 1 minute.

#### Note:

- \*1. Weekly Timer/Simple Timer/Auto Off Timer cannot be used at the same time.
- \*2. The weekly timer will not operate when any of the following conditions is in effect.

The timer feature is off; the system is in a malfunction state; a test run is in progress; the remote controller is undergoing self-check or remote controller check; the user is in the process of setting a function; the user is in the process of setting the timer; the user is in the process of setting the current day of the week or time; the system is under central control. (Specifically, the system will not carry out operations (unit on, unit off, or temperature setting) that are prohibited during these conditions.)

#### ► How to Set the Weekly Timer

- Be sure that you are at a standard control screen, and that the weekly timer indicator [1] is shown in the display.
- Press the Timer Menu button [2], so that the “Set Up” appears on the screen (at [2]).  
(Note that each press of the button toggles the display between “Set Up” and “Monitor”.)
- Press the Timer On/Off (Set Day) button [9] to set the day. Each press advances the display at [3] to the next setting, in the following sequence: “Sun Mon Tues Wed Thurs Fri Sat” → “Sun” → ... → “Fri” → “Sat” → “Sun Mon Tues Wed Thurs Fri Sat”...
- Press the  $\nabla$  or  $\Delta$  Operation button ([7] or [8]) as necessary to select the appropriate operation number (1 to 8) [4].  
\* Your inputs at Steps 3 and 4 will select one of the cells from the matrix illustrated below. (The remote-controller display at left shows how the display would appear when setting Operation 1 for Sunday to the values indicated below.)

#### Setup Matrix

Op No.	Sunday	Monday	...	Saturday	
No. 1	• 8:30 • ON • 23 °C				→ <Operation 1 settings for Sunday> Start the air conditioner at 8:30, with the temperature set to 23 °C.
No. 2	• 10:00 • OFF	• 10:00 • OFF	• 10:00 • OFF	• 10:00 • OFF	
...					→ <Operation 2 settings for every day> Turn off the air conditioner at 10:00.
No. 8					

#### Note:

By setting the day to “Sun Mon Tues Wed Thurs Fri Sat”, you can set the same operation to be carried out at the same time every day.  
(Example: Operation 2 above, which is the same for all days of the week.)

#### ► Setting the Weekly Timer

- Press the appropriate Set Time button [11] as necessary to set the desired time (at [5]).  
\* As you hold the button down, the time first increments in minute intervals, then in ten-minute intervals, and then in one-hour intervals.
- Press the ON/OFF button [1] to select the desired operation (ON or OFF), at [6].  
\* Each press changes the next setting, in the following sequence: No display(no setting) → “ON” → “OFF”
- Press the appropriate Set Temperature button [3] to set the desired temperature (at [7]).  
\* Each press changes the setting, in the following sequence: No display (no setting) ⇔ 24 ⇔ 25 ⇔ ... ⇔ 29 ⇔ 30 ⇔ 12 ⇔ ... ⇔ 23 ⇔ No display.  
(Available range: The range for the setting is 12 °C to 30 °C. The actual range over which the temperature can be controlled, however, will vary according to the type of the connected unit.)

Shows the time [5] [6] Shows the selected operation (ON or OFF) setting  
\* Does not appear if operation is not set.

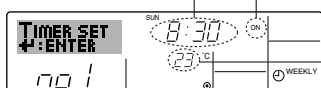

[7] Shows the temperature setting  
\* Does not appear if temperature is not set.

## 2. Operation

- After making the appropriate settings at Steps 5, 6 and 7, press the Filter  $\leftarrow$  button ④ to lock in the values.

To clear the currently set values for the selected operation, press and quickly release the Check (Clear) button ⑩ once.

\* The displayed time setting will change to “—:—”, and the On/Off and temperature settings will all disappear.

(To clear all weekly timer settings at once, hold down the Check (Clear) button ⑩ for two seconds or more. The display will begin flashing, indicating that all settings have been cleared.)

### Note:

Your new entries will be cancelled if you press the Mode (Return) button ② before pressing the Filter  $\leftarrow$  button ④.

If you have set two or more different operations for exactly the same time, only the operation with the highest Operation No. will be carried out.

- Repeat Steps 3 to 8 as necessary to fill as many of the available cells as you wish.
- Press the mode (Return) button ② to return to the standard control screen and complete the setting procedure.
- To activate the timer, press the Timer On/Off button ⑨, so that the “Timer Off” indication disappears from the screen. **Be sure that the “Timer Off” indication is no longer displayed.**

\* If there are no timer settings, the “Timer Off” indication will flash on the screen.

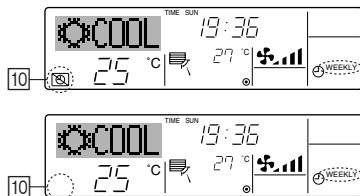
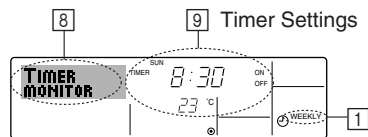

### ► How to View the Weekly Timer Settings

- Be sure that the weekly timer indicator is visible on the screen (at ⑩).
- Press the Timer Menu button ⑫ so that “Monitor” is indicated on the screen (at ⑧).
- Press the Timer On/Off (Set Day) button ⑨ as necessary to select the day you wish to view.
- Press the  $\nabla$  or  $\Delta$  Operation button (⑦ or ⑧) as necessary to change the timer operation shown on the display (at ⑨).  
\* Each press will advance to the next timer operation, in order of time setting.
- To close the monitor and return to the standard control screen, press the Mode (Return) button ②.

### ► To Turn Off the Weekly Timer

Press the Timer On/Off button ⑨ so that “Timer Off” appears at ⑩.

### ► To Turn On the Weekly Timer

Press the Timer On/Off button ⑨ so that the “Timer Off” indication (at ⑩) goes dark.

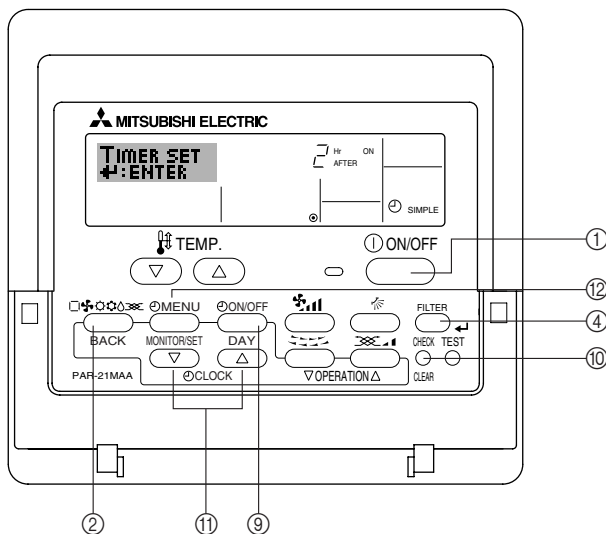

### 2.7.2. Using the Simple Timer

■ You can set the simple timer in any of three ways.

- Start time only: The air conditioner starts when the set time has elapsed.
- Stop time only: The air conditioner stops when the set time has elapsed.
- Start & stop times: The air conditioner starts and stops at the respective elapsed times.

■ The simple timer (start and stop) can be set only once within a 72-hour period.  
The time setting is made in hour increments.

### Note:

- Weekly Timer/Simple Timer/Auto Off Timer cannot be used at the same time.
- The simple timer will not operate when any of the following conditions is in effect.

The timer is off; the system is in malfunction state; a test run is in progress; the remote controller is undergoing self-check or remote controller check; the user is in the process of selecting a function; the user is in the process of setting the timer; the system is under central control. (Under these conditions, On/Off operation is prohibited.)

## 2. Operation

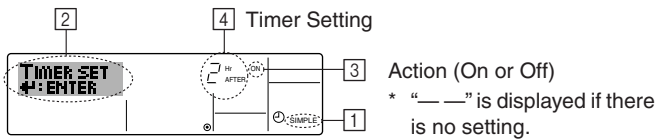

### ► How to Set the Simple Timer

1. Be sure that you are at a standard control screen, and that the simple timer indicator is visible in the display (at [1]).  
When something other than the Simple Timer is displayed, set it to SIMPLE TIMER using the function selection of remote controller (see 2.10. [4]-3 (3)).
2. Press the Timer Menu button [2], so that the "Set Up" appears on the screen (at [2]). (Note that each press of the button toggles the display between "Set Up" and "Monitor".)
3. Press the ON/OFF button [1] to display the current ON or OFF simple timer setting. Press the button once to display the time remaining to ON, and then again to display the time remaining to OFF. (The ON/OFF indication appears at [3]).
  - "ON" timer: The air conditioner will start operation when the specified number of hours has elapsed.
  - "OFF" timer: The air conditioner will stop operation when the specified number of hours has elapsed.
4. With "ON" or "OFF" showing at [3]: Press the appropriate Set Time button [1] as necessary to set the hours to ON (if "ON" is displayed) or the hours to OFF (if "OFF" is displayed) at [4].
  - Available Range: 1 to 72 hours
5. To set both the ON and OFF times, repeat Steps 3 and 4.  
\* Note that ON and OFF times cannot be set to the same value.
6. To clear the current ON or OFF setting: Display the ON or OFF setting (see step 3) and then press the Check (Clear) button [10] so that the time setting clears to "-" at [4]. (If you want to use only an ON setting or only an OFF setting, be sure that the setting you do not wish to use is shown as "-".)
7. After completing steps 3 to 6 above, press the Filter [4] button [4] to lock in the value.

#### Note:

Your new settings will be cancelled if you press the Mode (Return) button [2] before pressing the Filter [4] button [4].

8. Press the Mode (Return) button [2] to return to the standard control screen.
9. Press the Timer On/Off button [9] to start the timer countdown. When the timer is running, the timer value is visible on the display. **Be sure that the timer value is visible and appropriate.**

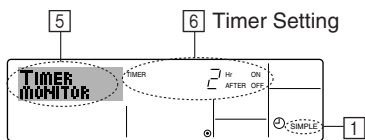

### ► Viewing the Current Simple Timer Settings

1. Be sure that the simple timer indicator is visible on the screen (at [1]).
2. Press the Timer Menu button [2], so that the "Monitor" appears on the screen (at [5]).
  - If the ON or OFF simple timer is running, the current timer value will appear at [6].
  - If ON and OFF values have both been set, the two values appear alternately.
3. Press the Mode (Return) button [2] to close the monitor display and return to the standard control screen.

### ► To Turn Off the Simple Timer...

Press the Timer On/Off button [9] so that the timer setting no longer appears on the screen (at [7]).

### ► To Turn On the Simple Timer...

Press the Timer On/Off button [9] so that the timer setting becomes visible at [7].

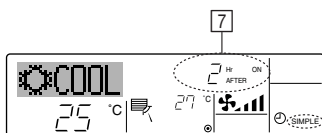
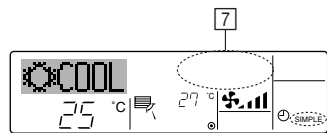

## 2. Operation

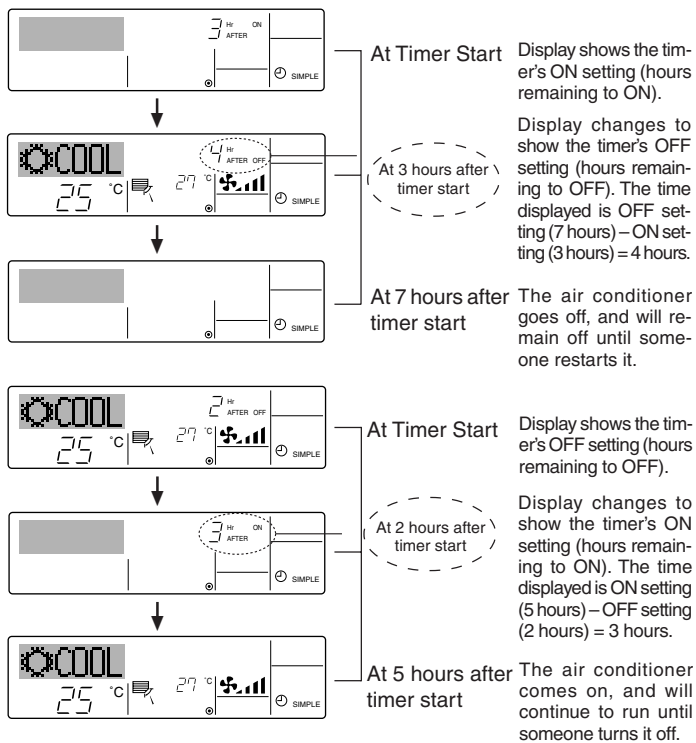

### Examples

If ON and OFF times have both been set at the simple timer, operation and display are as indicated below.

#### Example 1:

Start the timer, with ON time set sooner than OFF time

ON Setting: 3 hours

OFF Setting: 7 hours

#### Example 2:

Start the timer, with OFF time is sooner than ON time

ON Setting: 5 hours

OFF Setting: 2 hours

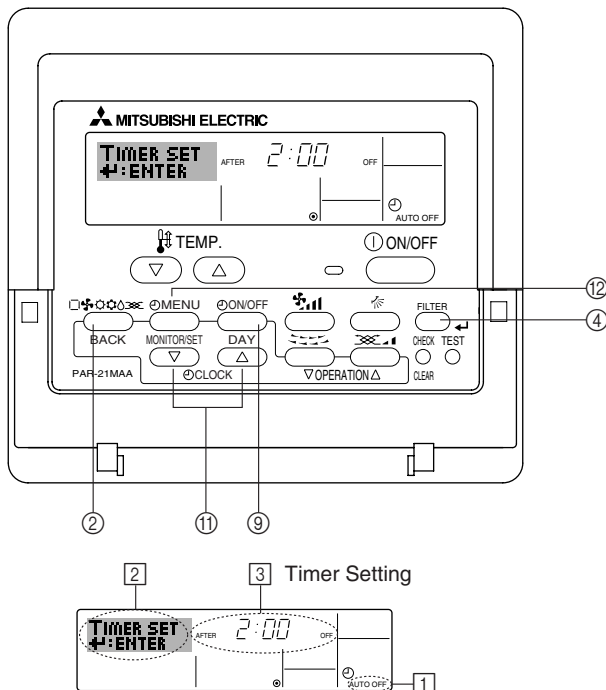

### 2.7.3. Using the Auto Off Timer

- This timer begins countdown when the air conditioner starts, and shuts the air conditioner off when the set time has elapsed.
- Available settings run from 30 minutes to 4 hours, in 30-minute intervals.

#### Note:

- \*1. Weekly Timer/Simple Timer/Auto Off Timer cannot be used at the same time.
- \*2. The Auto Off timer will not operate when any of the following conditions is in effect.

The timer is off; the system is in malfunction state; a test run is in progress; the remote controller is undergoing self-check or remote controller check; the user is in the process of selecting a function; the user is in the process of setting the timer; the system is under central control. (Under these conditions, On/Off operation is prohibited.)

#### ► How to Set the Auto Off Timer

1. Be sure that you are at a standard control screen, and that the Auto Off timer indicator is visible in the display (at ①). When something other than the Auto Off Timer is displayed, set it to AUTO OFF TIMER using the function selection of remote controller (see 2.10. [4]–3 (3)).
2. Hold down the Timer Menu button ⑫ for **3 seconds**, so that the “Set Up” appears on the screen (at ②). (Note that each press of the button toggles the display between “Set Up” and “Monitor”.)
3. Press the appropriate Set Time button ⑪ as necessary to set the OFF time (at ③).
4. Press the Filter button ④ to lock in the setting.

#### Note:

Your entry will be cancelled if you press the Mode (Return) button ② before pressing the Filter button ④.



## 2. Operation

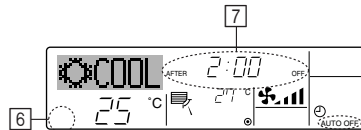
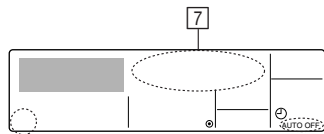
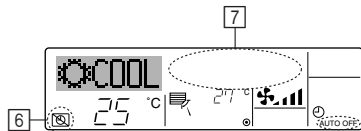
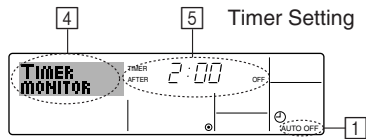

- Press the Mode (Return) button ② to complete the setting procedure and return to the standard control screen.
- If the air conditioner is already running, the timer starts countdown immediately. **Be sure to check that the timer setting appears correctly on the display.**

### ► Checking the Current Auto Off Timer Setting

- Be sure that the “Auto Off” is visible on the screen (at ①).
- Hold down the Timer Menu button ② for **3 seconds**, so that “Monitor” is indicated on the screen (at ④).
  - The timer remaining to shutdown appears at ⑤.
- To close the monitor and return to the standard control screen, press the Mode (Return) button ②.

### ► To Turn Off the Auto Off Timer...

- Hold down the Timer On/Off button ⑨ for **3 seconds**, so that “Timer Off” appears (at ⑥) and the timer value (at ⑦) disappears.

- Alternatively, turn off the air conditioner itself. The timer value (at ⑦) will disappear from the screen.

### ► To Turn On the Auto Off Timer...

- Hold down the Timer On/Off button ⑨ for **3 seconds**. The “Timer Off” indication disappears (at ⑥), and the timer setting comes on the display (at ⑦).
- Alternatively, turn on the air conditioner. The timer value will appear at ⑦.

## 2.8. Locking the remote controller buttons (Operation function limit controller)

- If you wish, you can lock the remote controller buttons. You can use the Function Selection of remote controller to select which type of lock to use. (For information about selecting the lock type, see section 2.10. [4]-2. (1)).

Specifically, you can use either of the following two lock types.

- Lock All Buttons:  
Locks all of the buttons on the remote controller.
- Lock All Except ON/OFF:  
Locks all buttons other than the ON/OFF button.

#### Note:

The “Locked” indicator appears on the screen to indicate that buttons are currently locked.

### ► How to Lock the Buttons

- While holding down the Filter button ④, press and hold down the ON/OFF button ① for 2 seconds. The “Locked” indication appears on the screen (at ①), indicating that the lock is now engaged.

\* If locking has been disabled in Function Selection of remote controller, the screen will display the “Not Available” message when you press the buttons as described above.

- If you press a locked button, the “Locked” indication (at ①) will blink on the display.

### ► How to Unlock the Buttons

- While holding down the Filter button ④, press and hold down the ON/OFF button ① for 2 seconds—so that the “Locked” indication disappears from the screen (at ①).

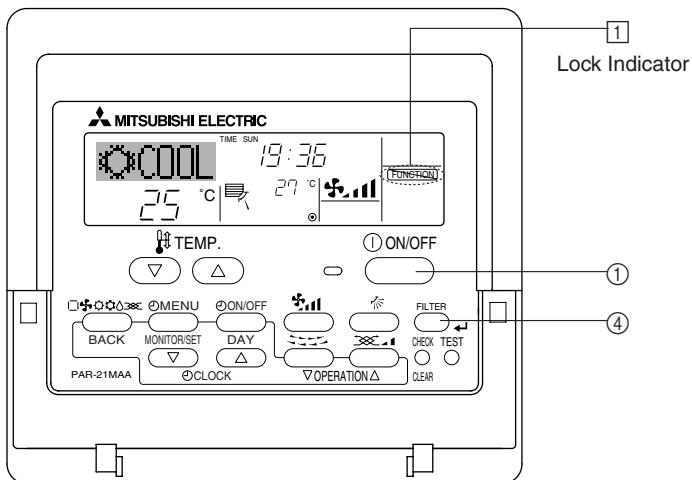

## 2. Operation

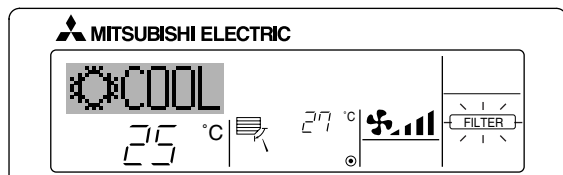
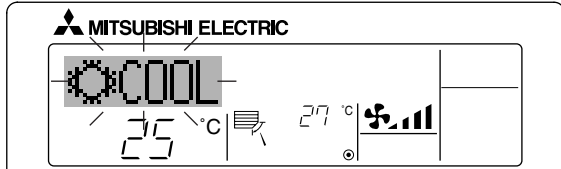
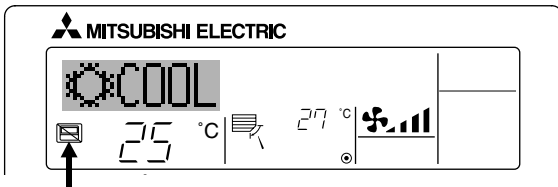

### 2.9. Other indications

#### 2.9.1. Centrally Controlled

- Displayed when operation is controlled by central controller, etc.
  - Restricted operations are shown below.
    - ON/OFF (including timer operation)
    - Operation mode
    - Set temperature

**Note:**

May also be individually restricted.

#### 2.9.2. Flashing Mode Indicator

- When flashes continuously
  - Displayed when another indoor unit connected to the outdoor unit is already operating in a different operation mode. Match with the operation mode of the other indoor unit.
- When mode switched after display flashes
  - Displayed when operation mode is restricted for each season by central controller, etc. Use another operation mode.

#### 2.9.3. Flashing "Filter"

- Indicates that the filter needs cleaning. Clean the filter.
- When resetting "FILTER" display
  - When the [FILTER] button is pressed two times successively after cleaning the filter, the display goes off and is reset.

**Note:**

- When two or more different types of indoor unit are controlled, the cleaning period differs with the type of filter. When the master unit cleaning period arrives, "FILTER" is displayed. When the filter display goes off, the cumulative time is reset.
- "FILTER" indicates the cleaning period when the air conditioner was used under general indoor air conditions by criteria time. Since the degree of dirtiness depends on the environmental conditions, clean the filter accordingly.
- The filter cleaning period cumulative time differs with the model.

#### 2.9.4. Flashing Error Codes

- If the ON lamp and error code are both flashing: This means that the air conditioner is out of order and operation has been stopped (and cannot resume). Take note of the indicated unit number and error code, then switch off the power to the air conditioner and call your dealer or servicier.

- If only the error code is flashing (while the ON lamp remains lit): Operation is continuing, but there may be a problem with the system. In this case, you should note down the error code and then call your dealer or servicier for advice.

\* If you have entered contact number to be called in the event of a problem, push the Check button to display it on the screen. (You can set this up under Function Selection of remote controller. For information, refer to section 2.10.)

If you have entered contact number to be called in the event of a problem, the screen displays this number. (You can set this up under Function Selection of remote controller. For information, refer to section 2.10.)

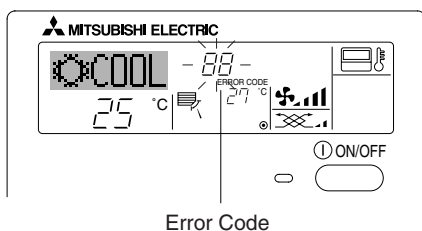
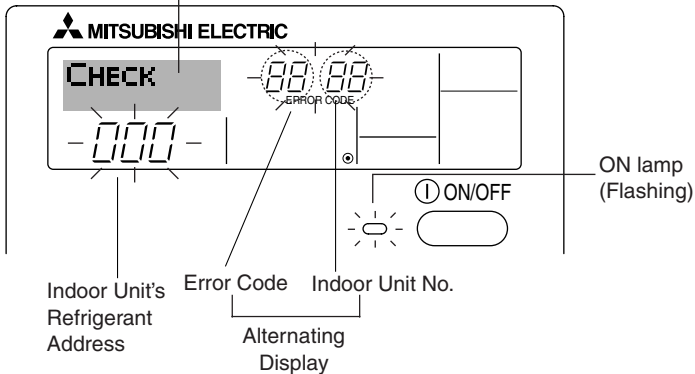

When the Check button is pressed:

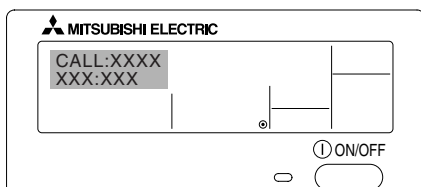

## 2. Operation

### 2.10. Function selection of remote controller

The setting of the following remote controller functions can be changed using the remote controller function selection mode. Change the setting when needed.

Item 1	Item 2	Item 3 (Setting content)
1. Change Language ("CHANGE LANGUAGE")	Language setting to display	<ul style="list-style-type: none"> <li>Display in multiple languages is possible.</li> </ul>
2. Function limit ("FUNCTION SELECTION")	(1) Operation function limit setting (operation lock) ("LOCKING FUNCTION")	<ul style="list-style-type: none"> <li>Setting the range of operation limit (operation lock)</li> </ul>
	(2) Use of automatic mode setting ("SELECT AUTO MODE")	<ul style="list-style-type: none"> <li>Setting the use or non-use of "automatic" operation mode</li> </ul>
	(3) Temperature range limit setting ("LIMIT TEMP FUNCTION")	<ul style="list-style-type: none"> <li>Setting the temperature adjustable range (maximum, minimum)</li> </ul>
3. Mode selection ("MODE SELECTION")	(1) Remote controller main/sub setting ("CONTROLLER MAIN/SUB")	<ul style="list-style-type: none"> <li>Selecting main or sub remote controller</li> <li>* When two remote controllers are connected to one group, one controller must be set to sub.</li> </ul>
	(2) Use of clock setting ("CLOCK")	<ul style="list-style-type: none"> <li>Setting the use or non-use of clock function</li> </ul>
	(3) Timer function setting ("WEEKLY TIMER")	<ul style="list-style-type: none"> <li>Setting the timer type</li> </ul>
	(4) Contact number setting for error situation ("CALL.")	<ul style="list-style-type: none"> <li>Contact number display in case of error</li> <li>Setting the telephone number</li> </ul>
4. Display change ("DISP MODE SETTING")	(1) Temperature display °C/°F setting ("TEMP MODE °C/°F")	<ul style="list-style-type: none"> <li>Setting the temperature unit (°C or °F) to display</li> </ul>
	(2) Suction air temperature display setting ("ROOM TEMP DISP SELECT")	<ul style="list-style-type: none"> <li>Setting the use or non-use of the display of indoor (suction) air temperature</li> </ul>
	(3) Automatic cooling/heating display setting ("AUTO MODE DISP C/H")	<ul style="list-style-type: none"> <li>Setting the use or non-use of the display of "Cooling" or "Heating" display during operation with automatic mode</li> </ul>

#### 2.10.1. Function selection flowchart

[1] Stop the air conditioner to start remote controller function selection mode. → [2] Select from item 1. → [3] Select from item 2. → [4] Make the setting. (Details are specified in item 3) → [5] Setting completed. → [6] Change the display to the normal one. (End)

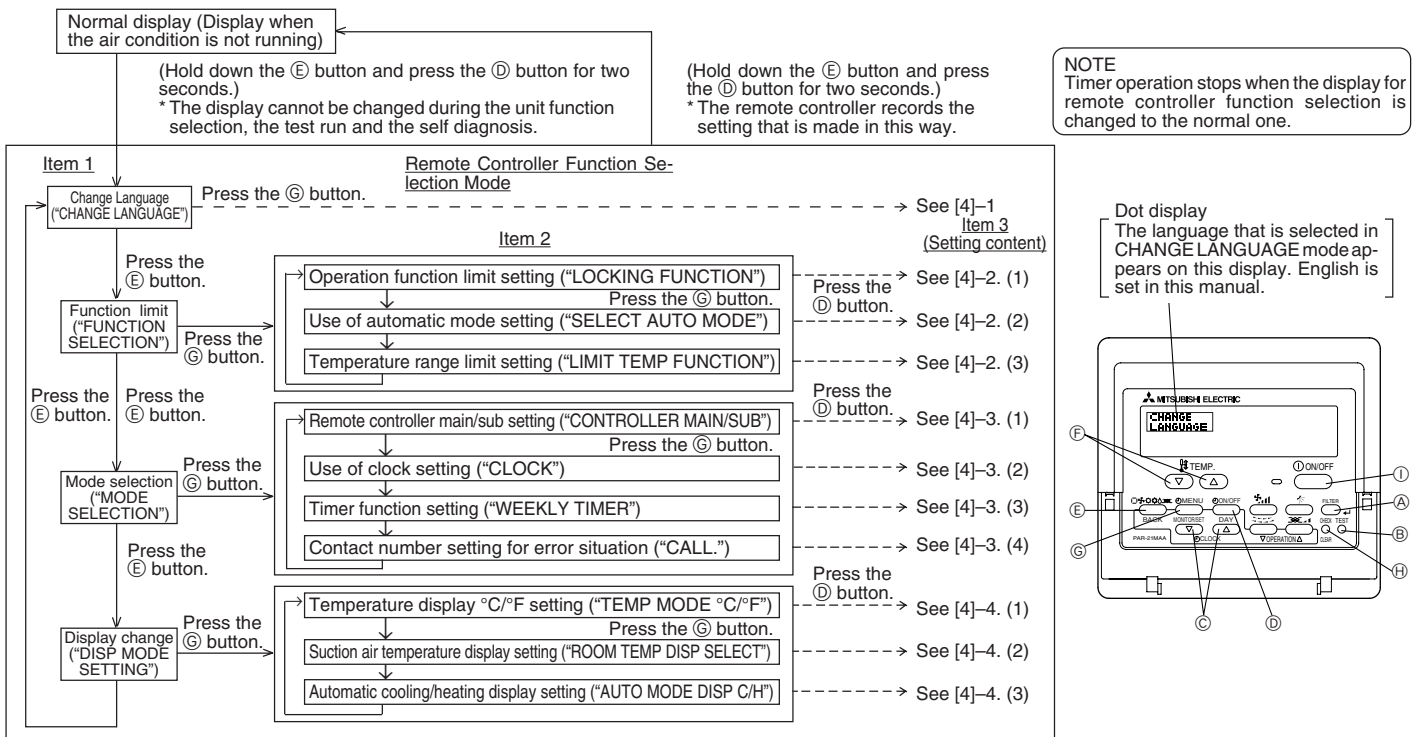

## 2. Operation

### 2.10.2. Detailed setting

#### [4]-1. CHANGE LANGUAGE setting

The language that appears on the dot display can be selected.

- Press the [⊖MENU] button ⑥ to change the language.
  - ① Japanese (JP), ② English (GB), ③ German (D), ④ Spanish (E), ⑤ Russian (RU), ⑥ Italian (I), ⑦ Chinese (CH), ⑧ French (F)

#### [4]-2. Function limit

##### (1) Operation function limit setting (operation lock)

- To switch the setting, press the [⊖ON/OFF] button ⑩.
  - ① no1 : Operation lock setting is made on all buttons other than the [⊖ON/OFF] button.
  - ② no2 : Operation lock setting is made on all buttons.
  - ③ OFF (Initial setting value) : Operation lock setting is not made.
- \* To make the operation lock setting valid on the normal screen, it is necessary to press buttons (Press and hold down the [FILTER] and [⊖ON/OFF] buttons at the same time for two seconds.) on the normal screen after the above setting is made.

##### (2) Use of automatic mode setting

When the remote controller is connected to the unit that has automatic operation mode, the following settings can be made.

- To switch the setting, press the [⊖ON/OFF] button ⑩.
  - ① ON (Initial setting value) : The automatic mode is displayed when the operation mode is selected.
  - ② OFF : The automatic mode is not displayed when the operation mode is selected.

##### (3) Temperature range limit setting

After this setting is made, the temperature can be changed within the set range.

- To switch the setting, press the [⊖ON/OFF] button ⑩.
  - ① LIMIT TEMP COOL MODE :  
The temperature range can be changed on cooling/dry mode.
  - ② LIMIT TEMP HEAT MODE :  
The temperature range can be changed on heating mode.
  - ③ LIMIT TEMP AUTO MODE :  
The temperature range can be changed on automatic mode.
  - ④ OFF (initial setting) : The temperature range limit is not active.
- \* When the setting, other than OFF, is made, the temperature range limit setting on cooling, heating and automatic mode is made at the same time. However, the range cannot be limited when the set temperature range has not changed.
- To increase or decrease the temperature, press the [TEMP. (▽) or (△)] button ⑨.
- To switch the upper limit setting and the lower limit setting, press the [TEMP. (▽) or (△)] button ⑨. The selected setting will flash and the temperature can be set.
- Settable range

Cooling/Dry mode:	Lower limit: 19°C ~ 30°C	Upper limit: 30°C ~ 19°C
Heating mode:	Lower limit: 17°C ~ 28°C	Upper limit: 28°C ~ 17°C
Automatic mode:	Lower limit: 19°C ~ 28°C	Upper limit: 28°C ~ 19°C
- \* The settable range varies depending on the unit to connect (Mr. Slim units, CITY MULTI units, and intermediate temperature units)

#### [4]-3. Mode selection setting

##### (1) Remote controller main/sub setting

- To switch the setting, press the [⊖ON/OFF] button ⑩.
  - ① Main : The controller will be the main controller.
  - ② Sub : The controller will be the sub controller.

##### (2) Use of clock setting

- To switch the setting, press the [⊖ON/OFF] button ⑩.
  - ① ON : The clock function can be used.
  - ② OFF : The clock function cannot be used.

##### (3) Timer function setting

- To switch the setting, press the [⊖ON/OFF] button ⑩ (Choose one of the followings).
  - ① WEEKLY TIMER (initial setting on MA deluxe) : The weekly timer can be used.
  - ② AUTO OFF TIMER : The auto off timer can be used.
  - ③ SIMPLE TIMER (Default setting on MA smooth) : The simple timer can be used.
  - ④ TIMER MODE OFF : The timer mode cannot be used.
- \* When the use of clock setting is OFF, the "WEEKLY TIMER" cannot be used.

##### (4) Contact number setting for error situation

- To switch the setting, press the [⊖ON/OFF] button ⑩.
  - ① CALL OFF : The set contact numbers are not displayed in case of error.
  - ② CALL \*\*\*\* \*\* \*\* : The set contact numbers are displayed in case of error.  
CALL\_ : The contact number can be set when the display is as shown on the left.
- Setting the contact numbers  
To set the contact numbers, follow the following procedures.  
Move the flashing cursor to set numbers. Press the [TEMP. (▽) and (△)] button ⑨ to move the cursor to the right (left). Press the [⊖CLOCK (▽) and (△)] button ⑩ to set the numbers.

## 2. Operation

### [4]-4. Display change setting

#### (1) Temperature display °C/°F setting

- To switch the setting, press the [⊖ON/OFF] button ①.
  - °C : The temperature unit °C is used.
  - °F : The temperature unit °F is used.

#### (2) Suction air temperature display setting

- To switch the setting, press the [⊖ON/OFF] button ①.
  - ON : The suction air temperature is displayed.
  - OFF : The suction air temperature is not displayed.

#### (3) Automatic cooling/heating display setting

- To switch the setting, press the [⊖ON/OFF] button ①.
  - ON : One of “Automatic cooling” and “Automatic heating” is displayed under the automatic mode is running.
  - OFF : Only “Automatic” is displayed under the automatic mode.

## 3. Care and cleaning

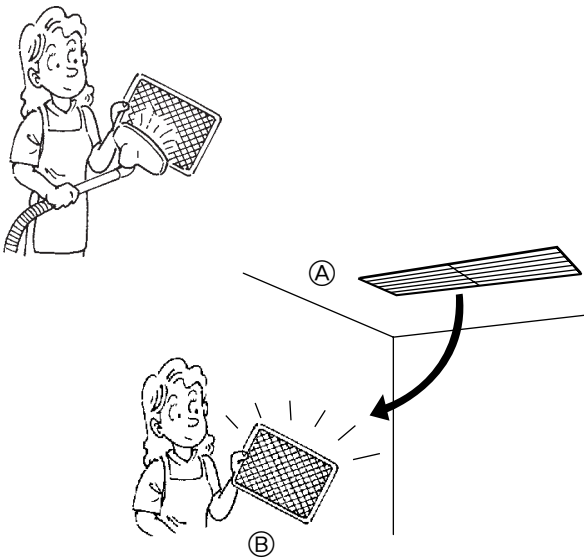

### 3.1. Cleaning the filters and the indoor unit

#### Cleaning the filters

- Clean the filters using a vacuum cleaner. If you do not have a vacuum cleaner, tap the filters against a solid object to knock off dirt and dust.
- If the filters are especially dirty, wash them in lukewarm water. Take care to rinse off any detergent thoroughly and allow the filters to dry completely before putting them back into the unit.

#### ⚠ Caution:

- Do not dry the filters in direct sunlight or by using a heat source, such as an electric heater: this may warp them.
- Do not wash the filters in hot water (above 50°C), as this may warp them.
- Make sure that the air filters are always installed. Operating the unit without air filters can cause malfunction.

#### ⚠ Caution:

- Before you start cleaning, stop operation and turn OFF the power supply.
- The air filter should be obtained locally. Be sure to check on the location and the way of setting with the contractor when the unit perform a trial run. (Example) The air filter should be attached to the indoor unit's air intake (rear side of unit).

Ⓐ Air intake

Ⓑ Filter

## 4. Troubleshooting

Before you call out a repair man, check the following table to see whether there is a simple solution to your problem.

### [for wired remote controller]

Problem	Solution	Problem	Solution
Unit does not cool or heat very well.	Clean the filter.	The start and stop functions are not available just after restarting the unit.	Wait about three minutes (operation has stopped to prevent damage to the air conditioner).
The unit stops operating before arriving at the set temperature in the heating mode.	Frost forms when the outdoor temperature is low and humidity is high. Wait for about 10 minutes for the frost to melt.	“PLEASE WAIT” is displayed in the remote controller.	An automatic startup test is being performed (will last for about two minutes).
A white mist is expelled from the indoor unit.	This may occur just after the unit is turned on when a high level of humidity is present in the room.	An error code is displayed in the remote controller.	A self-diagnostic function is being performed to preserve the air conditioner.
The indicators of the remote controller do not light up when operated.	Turn on the power switch. “●” will be displayed.		* Do not attempt to make repairs yourself. Turn the main switch off and contact the dealer from whom you bought the air conditioner. Provide him or her with the name of the unit and the information displayed in the remote controller.
CENTRALLY CONTROLLED is displayed in the remote controller.	The start and stop functions of the remote controller are not available when the CENTRALLY CONTROLLED message is lit.		

If none of the above apply, turn the main switch off and contact the dealer from whom you bought the air-conditioner, telling him the model name and the nature of the problem. Do not try to fix the unit yourself.

## 4. Troubleshooting

In any of the following cases, turn off the main power switch and contact your local dealer for service:

- The operation lamp (in the remote controller) flashes.
- The switches do not work properly.
- The circuit breaker trips frequently (or the fuse blows frequently).
- Water has accidentally been splashed into the unit.
- Water leaks from the unit.
- Something is accidentally dropped into the air-conditioner.
- An unusual noise is heard during operation.

The following do not indicate any malfunction:

Odours: smells such as tobacco or cosmetic odours may persist after they have been sucked into the unit.

Sound of liquid flowing inside indoor unit: this can occur during or after operation and is simply the sound of refrigerant being circulated inside the unit.

Ticking sound coming from indoor unit: this can occur when cooling or heating has just begun or has just stopped. It is caused by the indoor unit shrinking or expanding slightly due to the change in temperature.

**NOTE:** The refrigerant charged in the air conditioner is safe. Refrigerant normally does not leak, however, if refrigerant gas leaks indoors, and comes into contact with the fire of a fan heater, space heater, stove, etc., harmful substances will be generated.

Be sure to ask the service representative whether there is refrigerant leakage or not when repairs are carried out.

## 5. Installation, relocation and inspection

### Installation place

Avoid installing the air conditioner in the following places.

- Where flammable gas could leak.

#### ⚠ Caution:

Do not install the unit where flammable gas could leak.

If gas leaks and collects around the unit, it may cause an explosion.

- Where there is much machine oil.
- Salty place such as the seaside.
- Where sulfide gas is generated such as a hot spring.
- Where there is oil splashing or much oily smoke.

### Electrical work

- Provide an exclusive circuit for power supply of the air conditioner.
- Be sure to observe the breaker capacity.

#### ⚠ Warning:

The customer should not install this unit. If the unit is installed incorrectly, fire, electric shock, injury due to a falling unit, water leakage, etc. may result.

Do not connect using branched outlet or an extension cord, and do not attach many loads to one electric outlet.

A fire or electric shock may result from poor contact, poor insulation, exceeding the permissible current, etc.

Consult your dealer.

#### ⚠ Caution:

Apply grounding

Do not connect a grounding wire to a gas pipe, water pipe, lightning rod or ground wire of a telephone.

If a grounding is incorrect, it may cause an electric shock.

Install an earth leakage breaker depending on the place where the air conditioner is to be installed (humid place, etc.).

If the earth leakage breaker is not installed, it may cause an electric shock.

### Inspection and maintenance

- When the air conditioner is used for several seasons, the capacity may be lowered due to dirt inside the unit.
- Depending upon the conditions of use, an odor may be generated or dirt, dust, etc. may prevent proper drainage.
- It is recommended to apply inspection and maintenance (charged) by a specialist in addition to normal maintenance. Consult your dealer.

### Also consider operation sound

- Do not put an object around the air outlet of the outdoor unit. It may cause lowering of capacity or increase operating sound.
- If abnormal sound is heard during operation, consult your dealer.

### Relocation

- When the air conditioner is to be removed or reinstalled because of rebuilding, moving, etc., special techniques and work are required.

#### ⚠ Warning:

Repair or relocation should not be done by the customer.

If this is done incorrectly, it may cause a fire, electric shock, injury by dropping of the unit, water leakage, etc. Consult your dealer.

### Disposal

- To dispose of this product, consult your dealer.

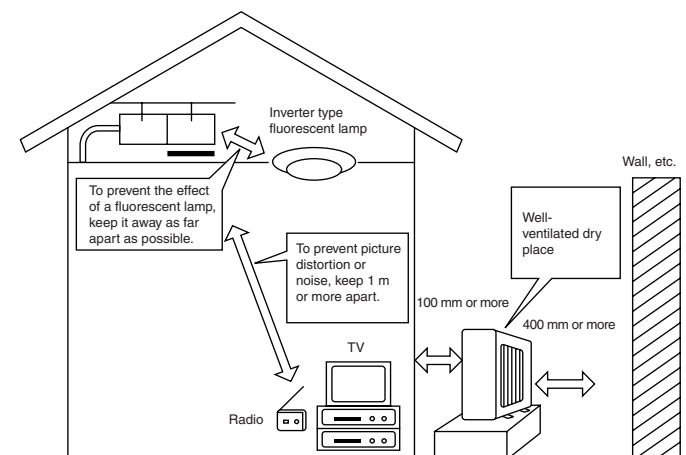

If you have any question, consult your dealer.

## 6. Specifications

Model		SEZ-KA35VA		SEZ-KA50VA		SEZ-KA60VA			
Function		Cooling	Heating	Cooling	Heating	Cooling	Heating		
Power supply		~N, 230V, 50Hz							
Capacity	kW	3.5	4.0	5.0	5.9	5.5	6.9		
	BTU/h	11,900	13,600	17,100	20,100	18,800	23,500		
Input		kW	1.06	1.10	1.78	1.84	1.96	2.45	
Indoor unit		SEZ-KA35VA		SEZ-KA50VA		SEZ-KA60VA			
Fan	Airflow (Lo-Hi)	CMM		10-13		12-17		12-20	
	Ext. static pressure	Pa (mmAq)		Std. : 30 (3) Max. : 50 (5)		Std. : 30 (3) Max. : 50 (5)		Std. : 30 (3) Max. : 50 (5)	
	Noise level (Lo-Hi)	dB (A)		30-35		31-39		32-43	
Weight		kg		33.5		33.5		33.5	
Outdoor unit		SUZ-KA35VA		SUZ-KA50VA		SUZ-KA60VA			
Noise level (Lo-Hi)		dB (A)		48		55		55	
Refrigerant R410A		kg		1.05		1.6		1.8	
Weight		kg		35		53		53	

- Notes: 1. Rating conditions (cooling) Indoor : 27°C DB, 19°C WB      Outdoor : 35°C DB  
 2. Rating conditions (heating) Indoor : 20°C DB      Outdoor : 7°C DB, 6°C WB  
 3. Specifications subject to change without notice.

### Guaranteed operating range

		Indoor	Outdoor	
			KA35	KA50, KA60
Cooling	Upper limit	32°C DB, 23°C WB	46°C DB, –	43°C DB, –
	Lower limit	21°C DB, 15°C WB	-10°C DB, –	
Heating	Upper limit	27°C DB, –	24°C DB, 18°C WB	
	Lower limit	20°C DB, –	-10°C DB, -11°C WB	

Units should be installed by licensed electric contractor accordingly to local code requirement.

This product is designed and intended for use in the residential,  
commercial and light-industrial environment.

The product at hand is based on the following EU regulations:

- Low Voltage Directive 73/23/ EEC
- Electromagnetic Compatibility Directive 89/336/ EEC

Please be sure to put the contact address/telephone number on  
this manual before handing it to the customer.